

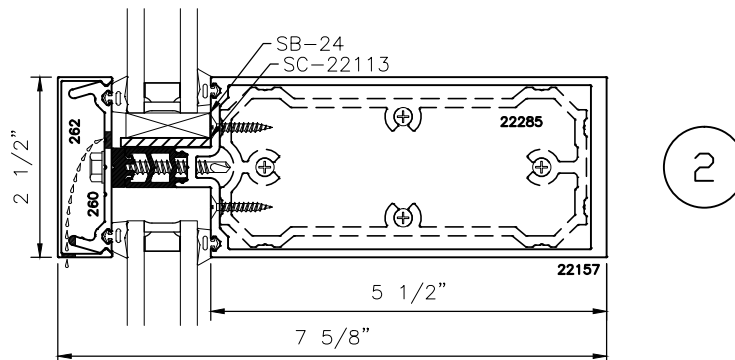

250xpt-2

2-1/2" X 7-5/8" (5-1/2" B.M.) HIGH PERFORMANCE THERMAL CURTAIN WALL F & T ANCHOR DETAILS

* MINIMUM RECOMMENDED FOR THERMAL ISOLATION.
INCREASE AS REQUIRED TO COMPLY WITH SEALANT
MANUFACTURERS' INSTRUCTIONS

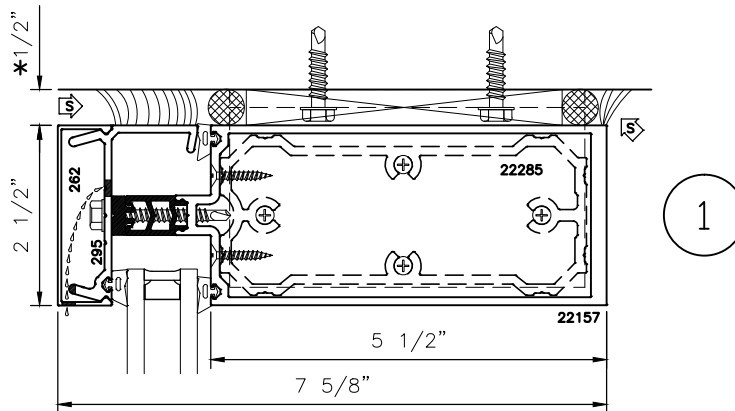
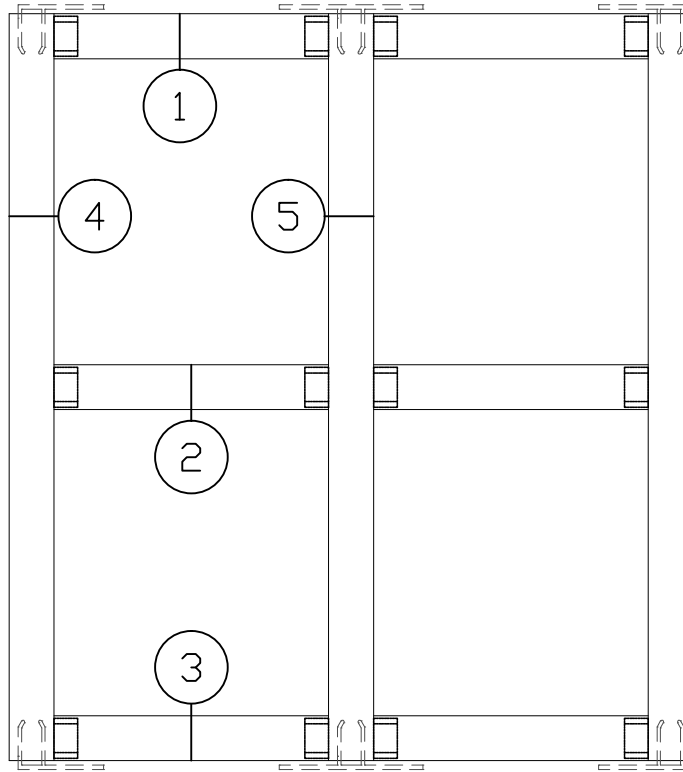



250xpt-2

2-1/2" X 7-5/8" (5-1/2" B.M.) HIGH PERFORMANCE THERMAL CURTAIN WALL F & T ANCHOR DETAILS

* MINIMUM RECOMMENDED FOR THERMAL ISOLATION.
INCREASE AS REQUIRED TO COMPLY WITH SEALANT
MANUFACTURERS' INSTRUCTIONS

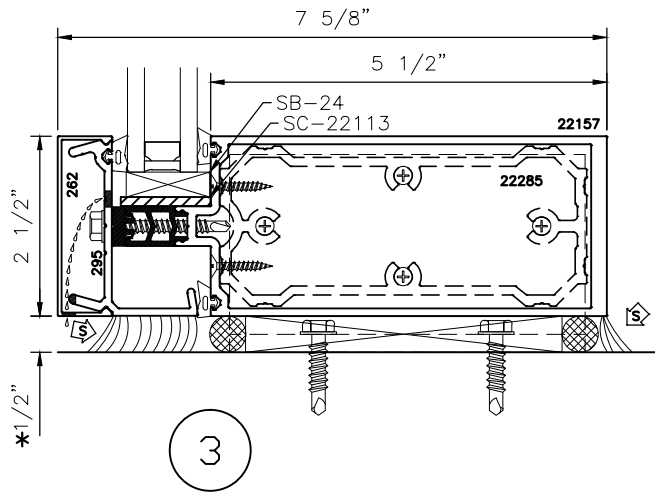

HEX HEAD SS BOLTS
ANCHOR FASTENERS (TYP.).
CONTINUOUS BED OF
SEALANT UNDER "F" & "T"
ANCHORS

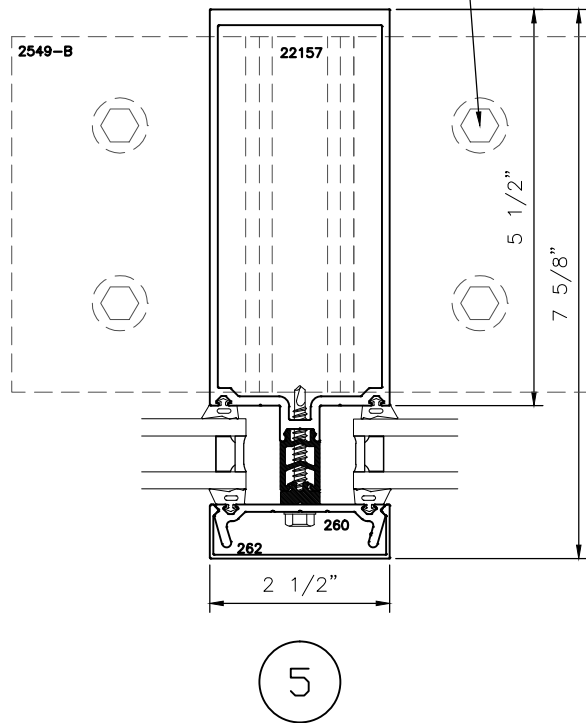

HEX HEAD SS BOLTS
ANCHOR FASTENERS (TYP.).
CONTINUOUS BED OF
SEALANT UNDER "F" & "T"
ANCHORS

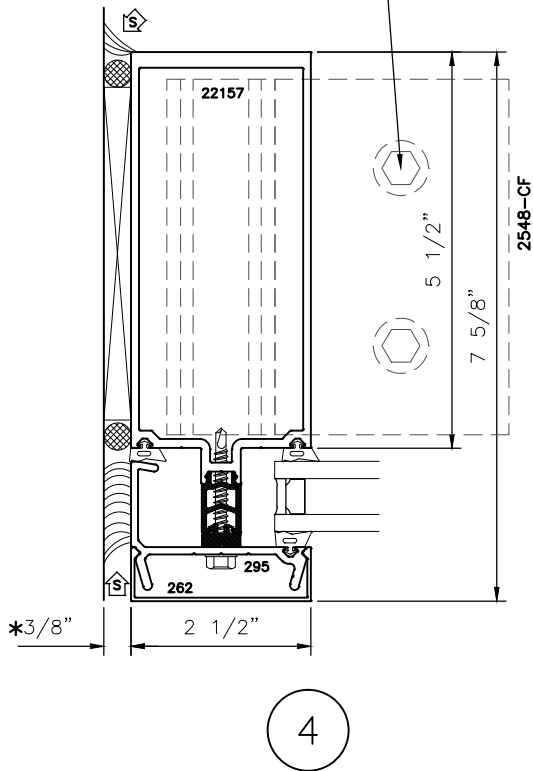



250xpt-2

2-1/2" X 7-5/8" (5-1/2" B.M.)
HIGH PERFORMANCE
THERMAL CURTAIN WALL
F & T ANCHOR DETAILS

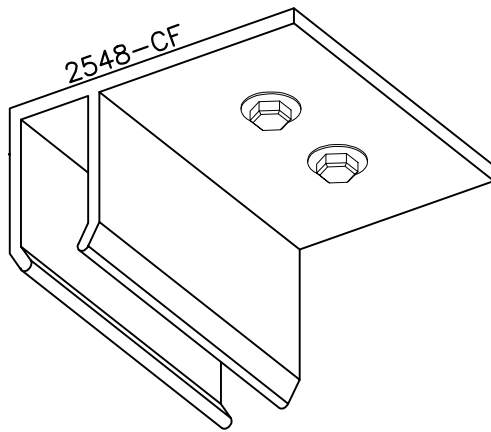

TOP F-ANCHOR

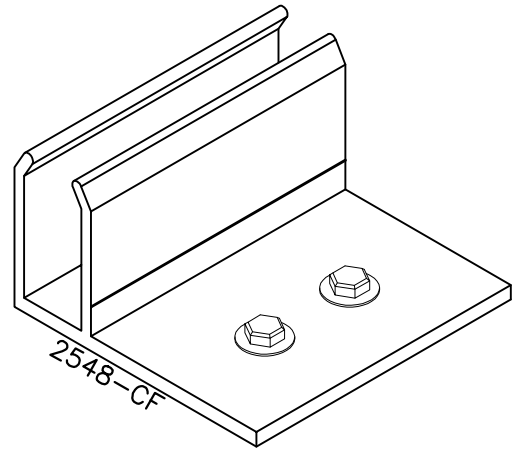

BOTTOM F-ANCHOR

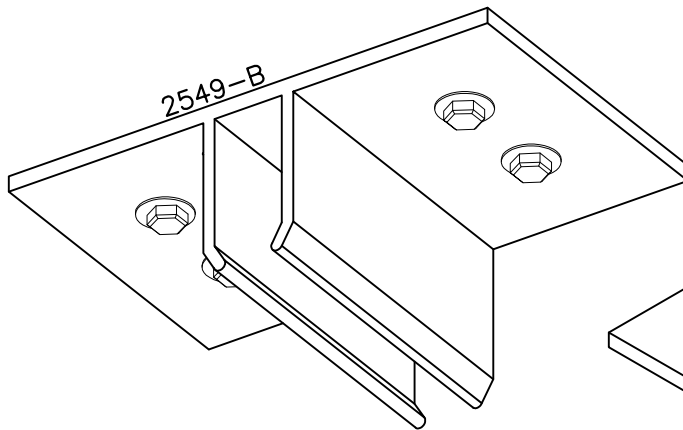

TOP T-ANCHOR

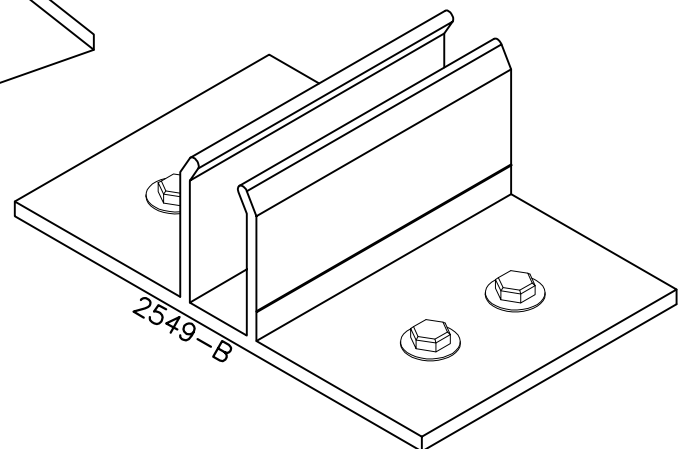

BOTTOM T-ANCHOR