



MANKO

250xpt-2

2-1/2" X 8-7/8" (6-3/4" B.M.) HIGH PERFORMANCE THERMAL CURTAIN WALL STANDARD / OPTIONAL DETAILS

* MINIMUM RECOMMENDED FOR THERMAL ISOLATION.
INCREASE AS REQUIRED TO COMPLY WITH SEALANT
MANUFACTURERS' INSTRUCTIONS

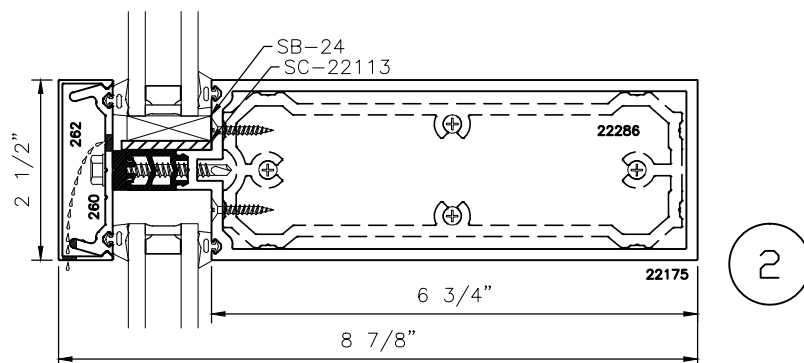
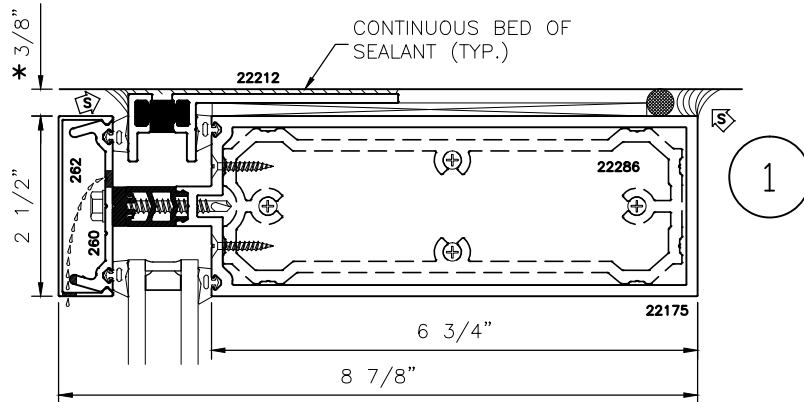
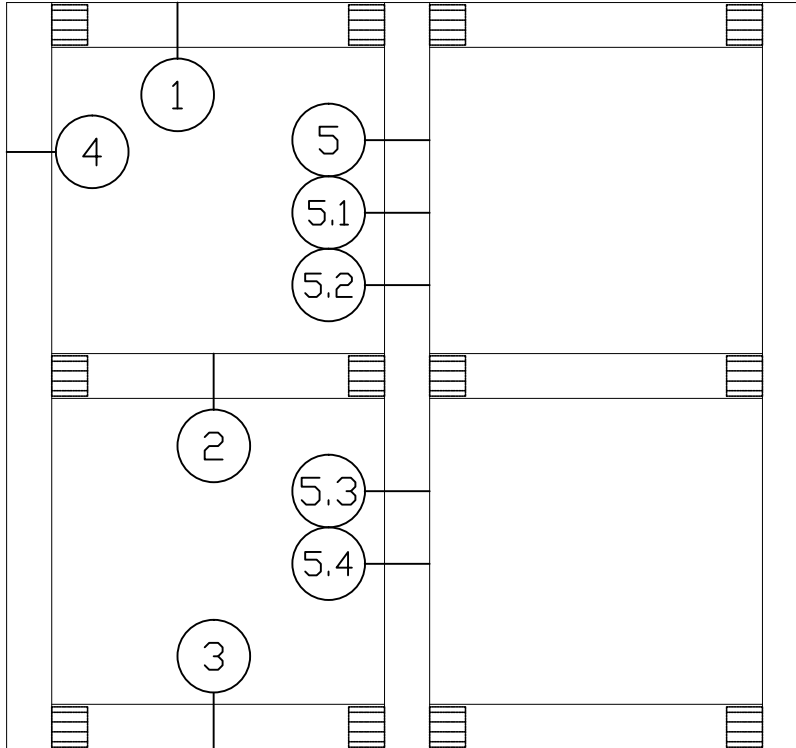



MANKO

250xpt-2

2-1/2" X 8-7/8" (6-3/4" B.M.) HIGH PERFORMANCE THERMAL CURTAIN WALL STANDARD/OPTIONAL DETAILS

* MINIMUM RECOMMENDED FOR THERMAL ISOLATION.
INCREASE AS REQUIRED TO COMPLY WITH SEALANT
MANUFACTURERS' INSTRUCTIONS

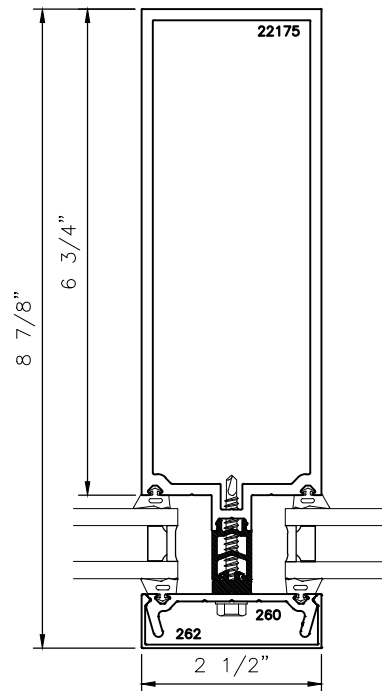
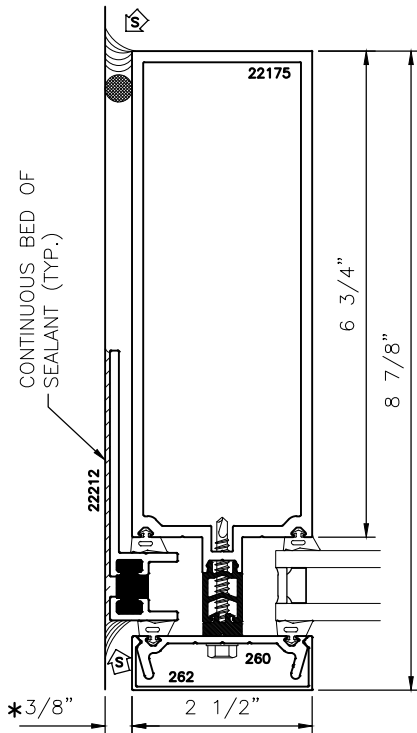
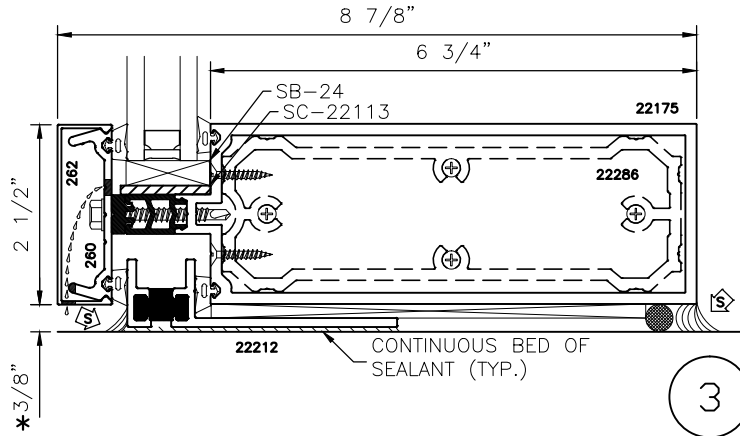



MANKO

250xpt-2

2-1/2" X 8-7/8" (6-3/4" B.M.) HIGH PERFORMANCE THERMAL CURTAIN WALL STANDARD/OPTIONAL DETAILS

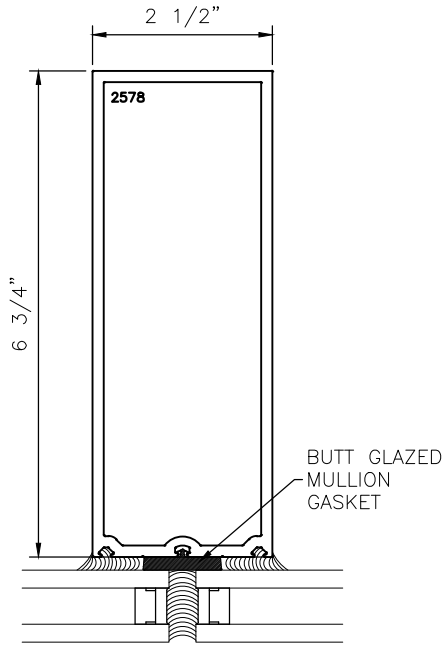

OPT.
5.1

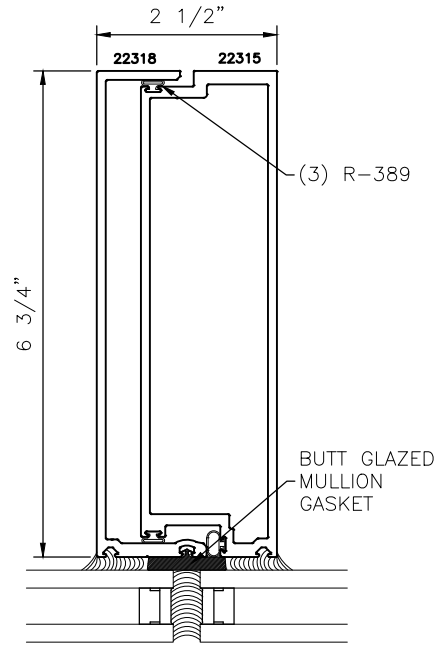

OPT.
5.3

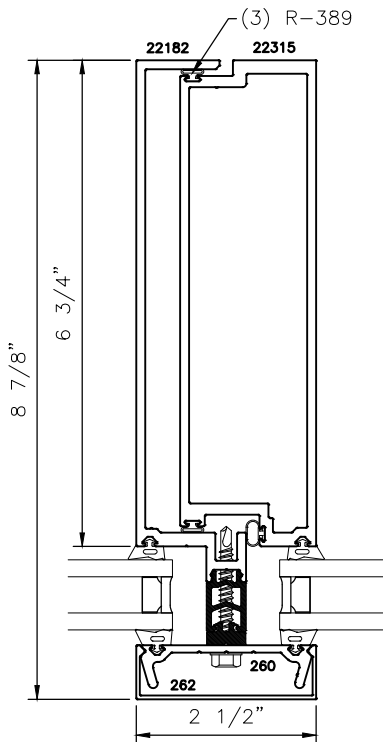

OPT.
5.2

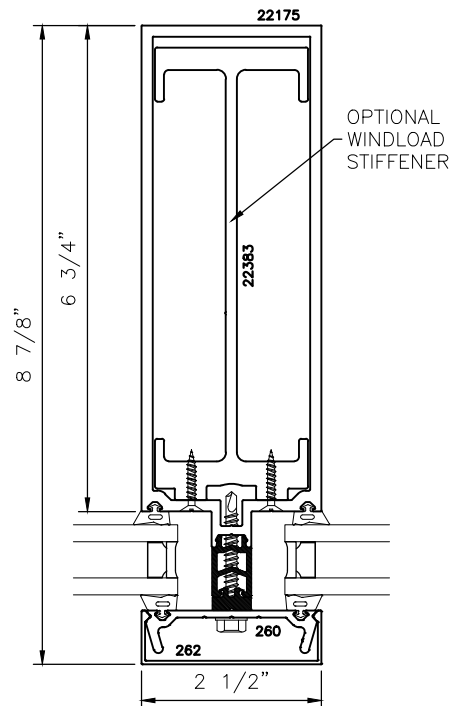

OPT.
5.4