



MANKO

250xpt-3

2-1/2" X 9-5/8" (6-3/4" B.M.) HIGH PERFORMANCE THERMAL CURTAIN WALL STANDARD / OPTIONAL DETAILS

* MINIMUM RECOMMENDED FOR THERMAL ISOLATION.
INCREASE AS REQUIRED TO COMPLY WITH SEALANT
MANUFACTURERS' INSTRUCTIONS

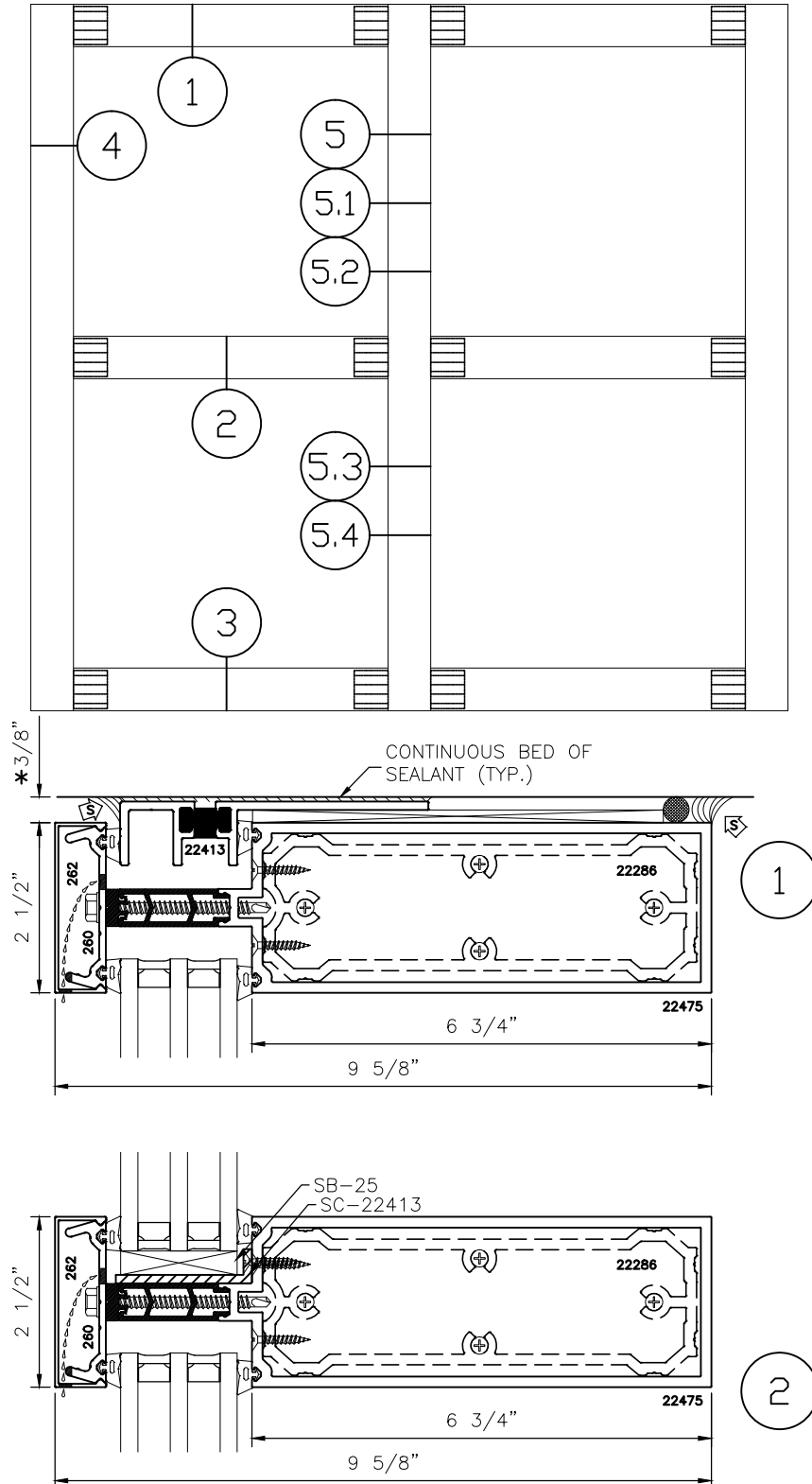



MANKO

250xpt-3

2-1/2" X 9-5/8" (6-3/4" B.M.) HIGH PERFORMANCE THERMAL CURTAIN WALL STANDARD/OPTIONAL DETAILS

* MINIMUM RECOMMENDED FOR THERMAL ISOLATION.
INCREASE AS REQUIRED TO COMPLY WITH SEALANT
MANUFACTURERS' INSTRUCTIONS

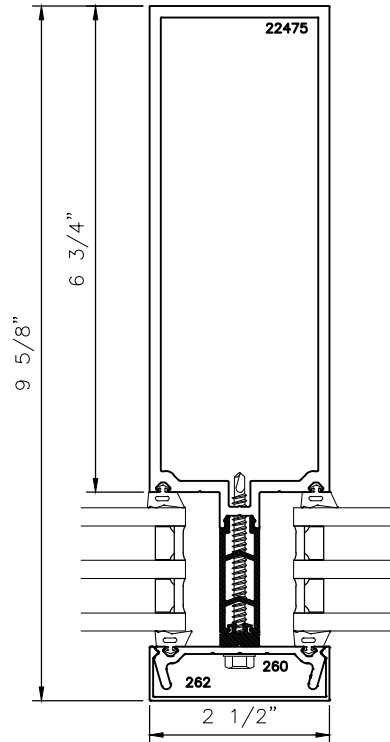
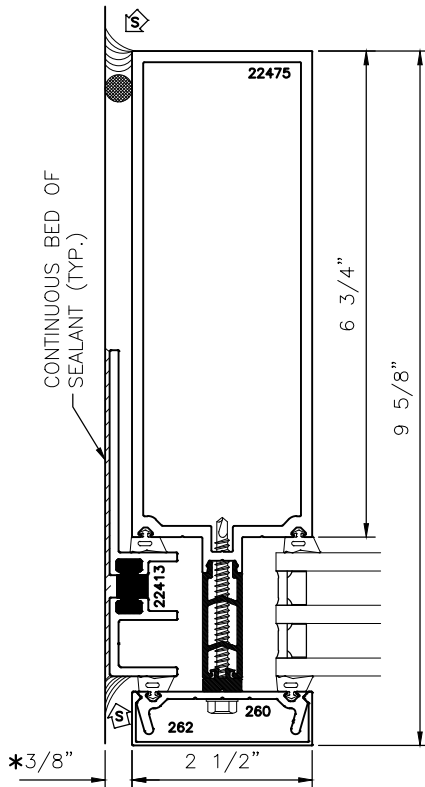
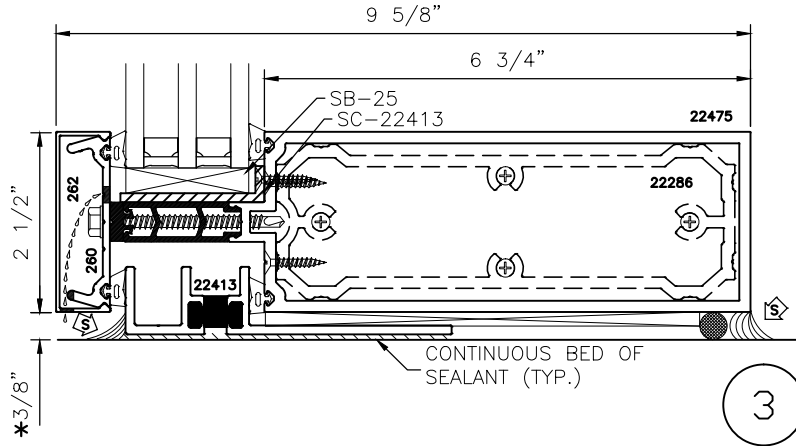



MANKO

250xpt-3

2-1/2" X 9-5/8" (6-3/4" B.M.) HIGH PERFORMANCE THERMAL CURTAIN WALL STANDARD/OPTIONAL DETAILS

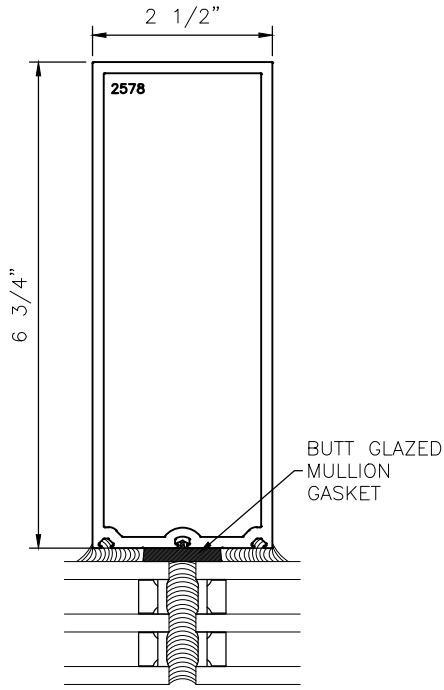

OPT.

5.1

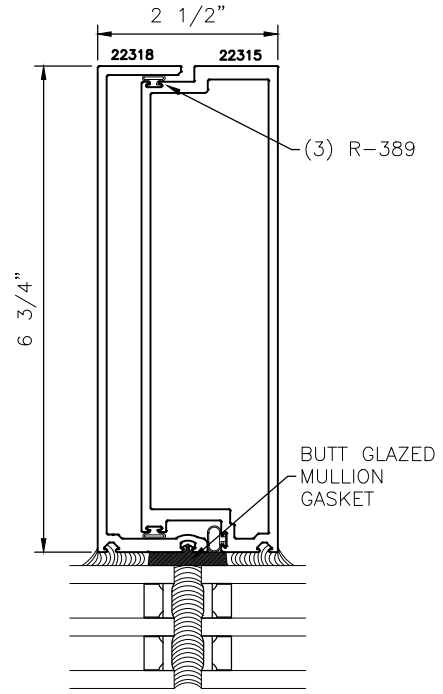

OPT.

5.3

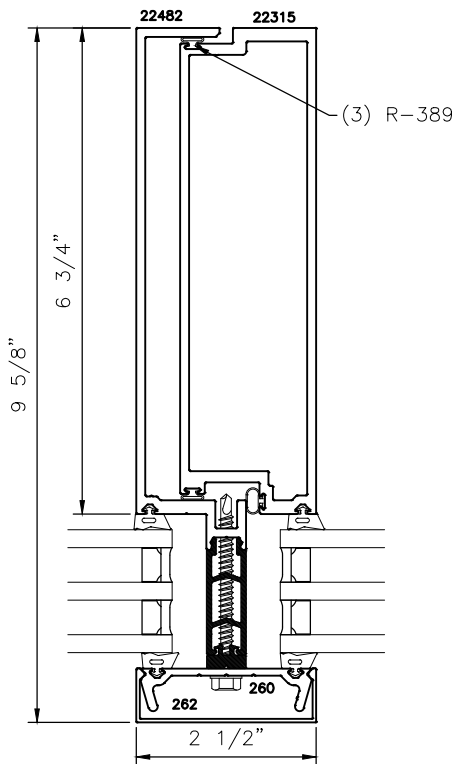

OPT.

5.2

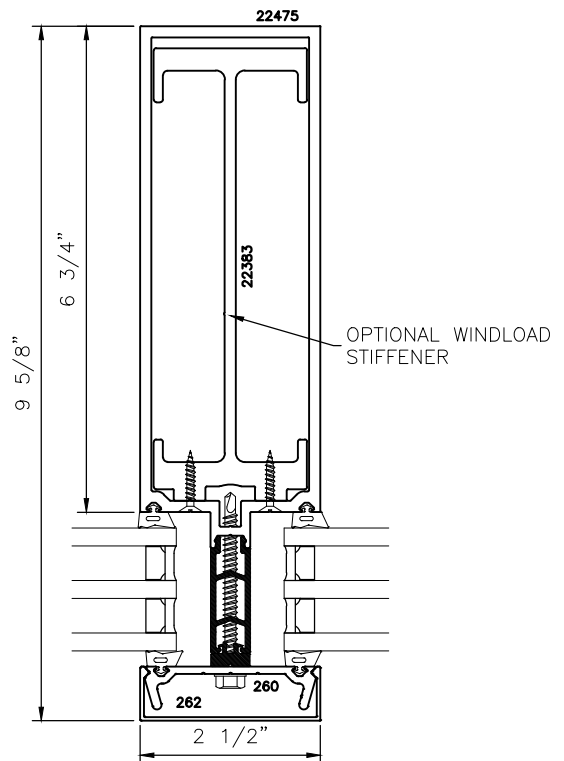

OPT.

5.4