

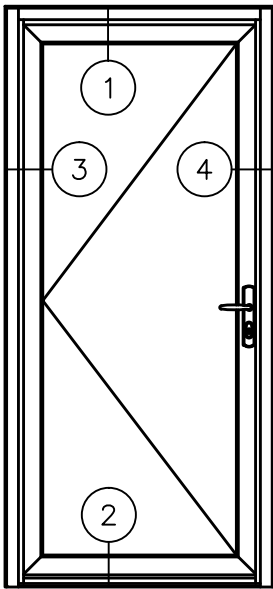

2300i

4" THERMAL TERRACE DOOR
INSWING DOORS
STANDARD DETAILS



SINGLE DOOR
WITHOUT TRANSOM
STANDARD CONFIGURATION

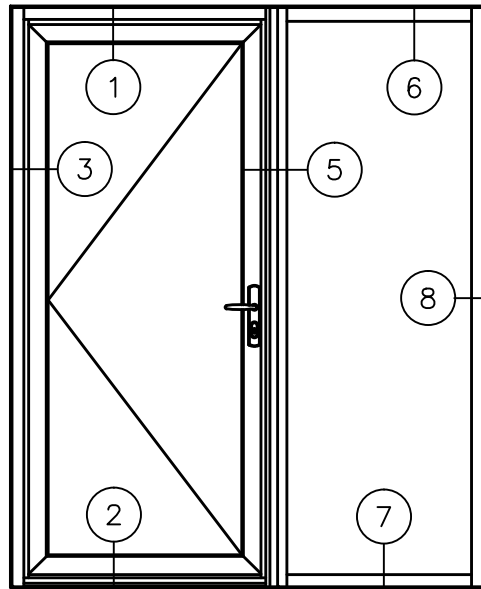

SINGLE DOOR
WITHOUT 3527i SIDELITE
STANDARD CONFIGURATION

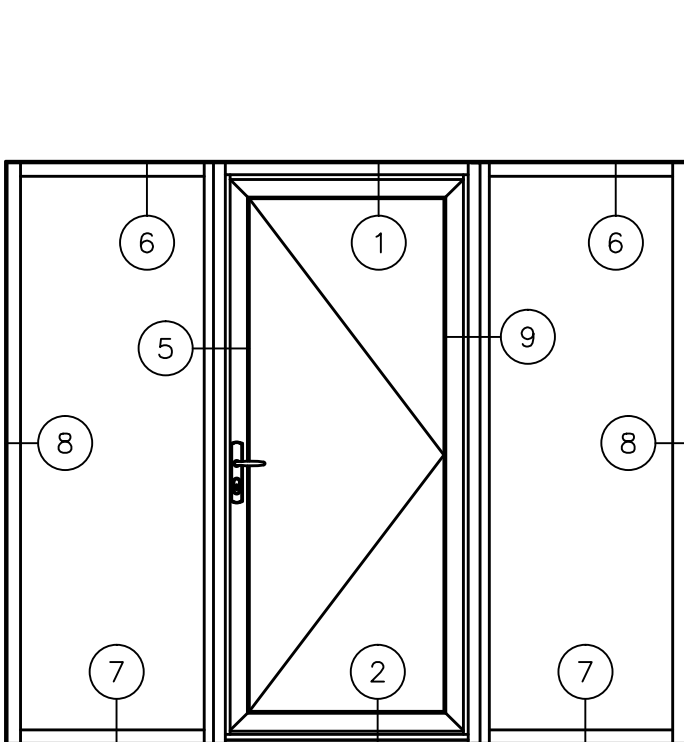

SINGLE DOOR
WITH 3527i SIDELITES
STANDARD CONFIGURATION

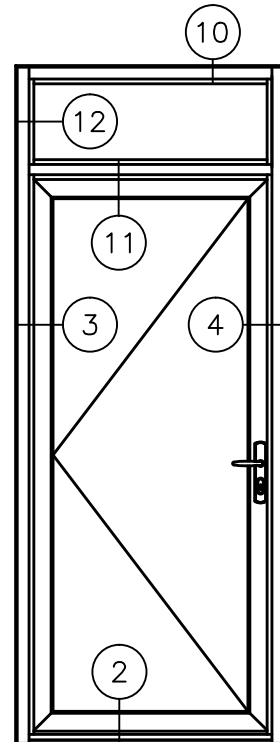

SINGLE DOOR
WITH TRANSOM
STANDARD CONFIGURATION



2300i

4" THERMAL TERRACE DOOR
 INSWING DOORS
 STANDARD DETAILS

* MINIMUM RECOMMENDED FOR THERMAL ISOLATION.
 INCREASE AS REQUIRED TO COMPLY WITH SEALANT
 MANUFACTURERS' INSTRUCTIONS

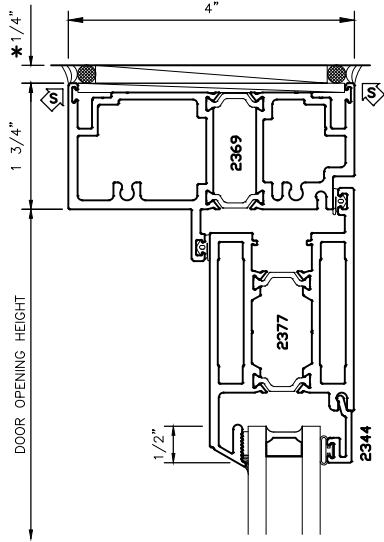

1

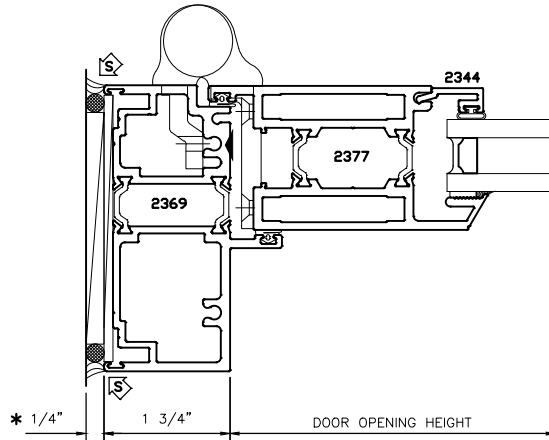

3

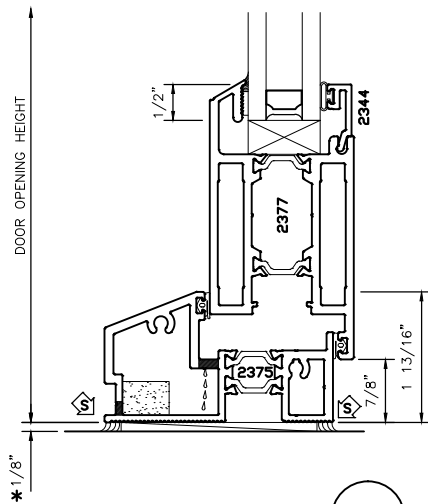

2

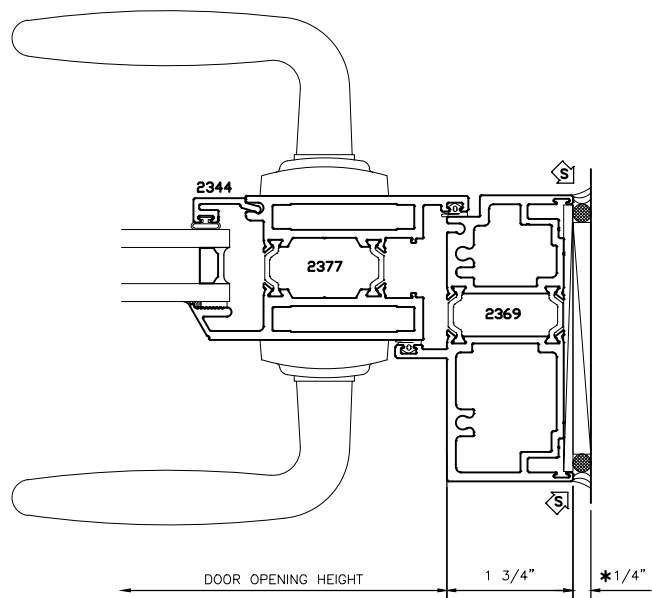

4



2300i

4" THERMAL TERRACE DOOR
 INSWING DOORS
 STANDARD DETAILS

* MINIMUM RECOMMENDED FOR THERMAL ISOLATION.
 INCREASE AS REQUIRED TO COMPLY WITH SEALANT
 MANUFACTURERS' INSTRUCTIONS

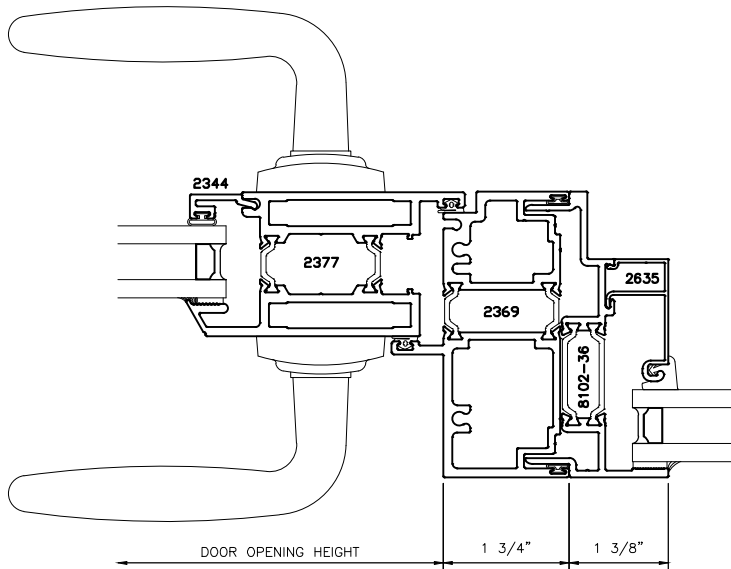

5

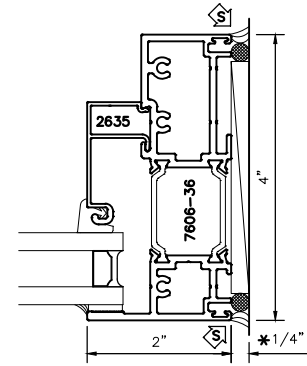

8

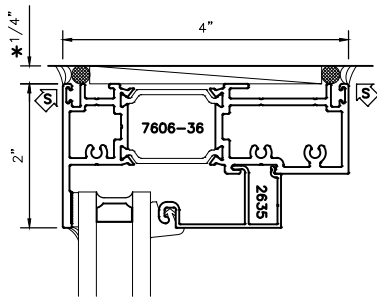

6

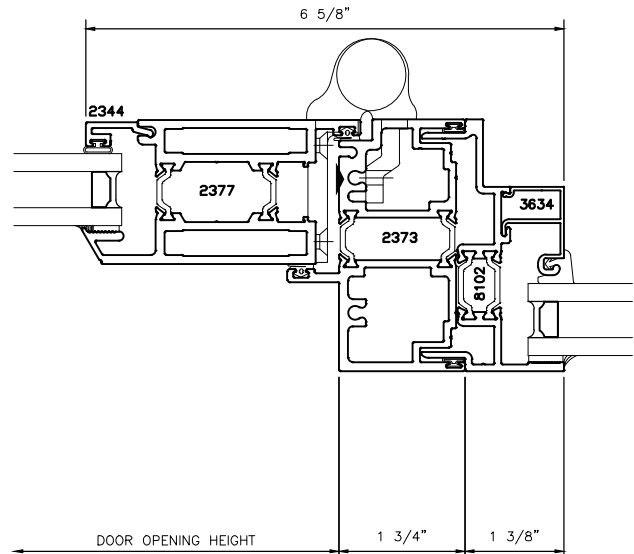

9

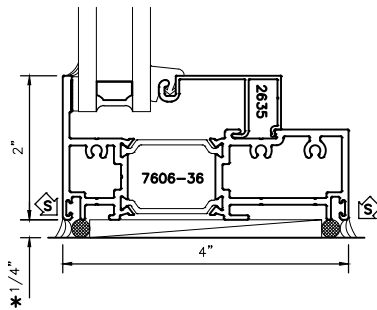

7



2300i

4" THERMAL TERRACE DOOR IN SWING DOORS STANDARD DETAILS

* MINIMUM RECOMMENDED FOR THERMAL ISOLATION.
INCREASE AS REQUIRED TO COMPLY WITH SEALANT
MANUFACTURERS' INSTRUCTIONS

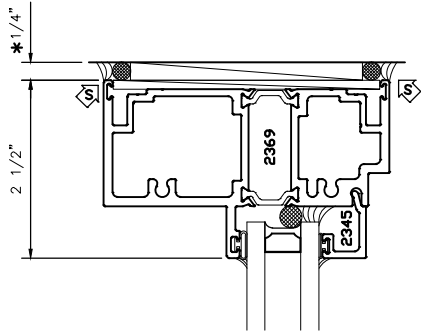

10

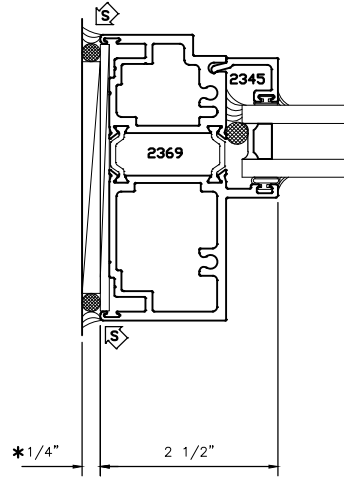

12

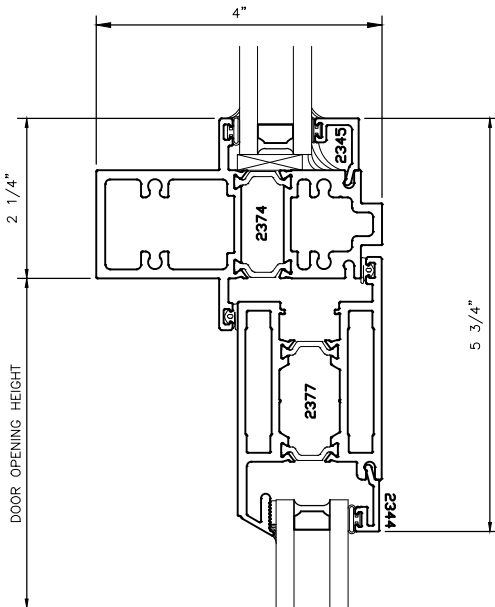

11